



GROB-WERKE GMBH & CO. KG

Unternehmensbereich

Burkhart Grob Flugzeugbau

8939 Mattsies

Am Flugplatz

Telefon 08268/411

Telex 539 623'

FLIGHT MANUAL

GROB G 103 »TWIN II«

This manual must be carried on board of the sail-plane at all times.

This Flight manual is FAA approved for U.S. registered gliders in accordance with the provisions of 14 CFR Section 21.29. and is required by FAA Type Certificate Data Sheet No. G 39 EU.

Registration: N228BG Factory Serial No. 33995-K-228

Owner: Utah Soaring Association

German edition of operating instructions are approved under § 12 (1) 2. of LuftGerPO.

Published September 1981

LBA approved

Date 17th march 1982

Approval of translation has been done by best knowledge and judgement - in any case the original text in German language is authoritative.

1.1. Updates

No.	Page	Reference	Date	Signature	LBA - Approval
1	1, 1a, 8, 10, 12, 14, 17, 19	Modification of serial No. 3730 and subsequent	June 1982		
2	1, 1a, 12, 21, 5a	Automatic connection of elevator and spring trim system os S/N 33879 and subsequent (only for GROB G 103A)	26. Sept. 84		
3	1, 1a, 5a	MSB 315-65	16.10.2003		
4	1, 1a, 5a	OSB 315-66	16.10.2003		25. NOV. 2003
					

List of effective pages

Page	Date
1	16.10.2003
1a	16.10.2003
2	Sept. 81
3	Sept. 81
4	Sept. 81
5	Sept. 81
5a (*)	16.10.2003
6	17 th March 82
7	17 th March 82
8	16 th June 82
9	Sept. 81
10	16 th June 82
11	17 th March 82
12	16 th June 82
12a	26 th Sept. 84
13	17 th March 82
14	16 th June 82
15	17 th March 82
16	17 th March 82
17	16 th June 82
18	17 th March 82
19	16 th June 82
20	17 th March 82
21	26 th Sept. 84
22	Sept. 81
23	17 th March 82
24	17 th March 82
25	17 th March 82
26	17 th March 82
27	17 th March 82
28	17 th March 82
29	17 th March 82
30	17 th March 82
31	17 th March 82

(*) only for GROB G 103A TWIN II ACRO

I. 2 Contents

	page
I. General	
I. 1 Log of revisions	1, 1a
I. 2 Contents (LBA approved pages: 1, 1a and 6 through 31, except 9 and 22)	2, 3
I. 3 Photograph	4
I. 4 Drawing	5
I. 5 Description	6
II. Operating limitations	
II. 1 Airworthiness Group	6
II. 2 Permitted operating conditions	6
II. 3 Minimum equipment	6
II. 4 Maximum Speeds	7
II. 5 Flight envelope	7
II. 6 Weight limits	8
II. 7 Centre of gravity position	8
II. 8 Load scheme, weighing report	8, 9
II. 9 Tow hooks and cable length	10
II. 10 Weak link strength	10
II. 11 Tire pressure	10
II. 12 Crosswinds	10
II. 13 Placards, control markings and instrument markings	11, 12, 12a 13, 14, 15
III. Emergency procedures	
III. 1 Recovery from the spin	16
III. 2 Emergency canopy jettison and exit	16
III. 3 Miscellaneous (Rain, ice, groundloops)	16

IV.	Normal procedures	
IV. 1	Cockpit and controls (Picture)	17, 18, 19, 20
IV. 2	Daily preflight inspection	21, 22
IV. 3	Control checks before take off	23
IV. 4	Take off	23
IV. 5	Free Flight	24
IV. 6	Slow flying and stalls	24
IV. 7	High speed flight	24
IV. 8	Simple Aerobatics	25
IV. 9	Approach and landing	26
IV. 10	Storage	27
V.	Appendices	
V. 1	Flight performance	28
V. 2	Determination of the center of gravity	29, 30, 31

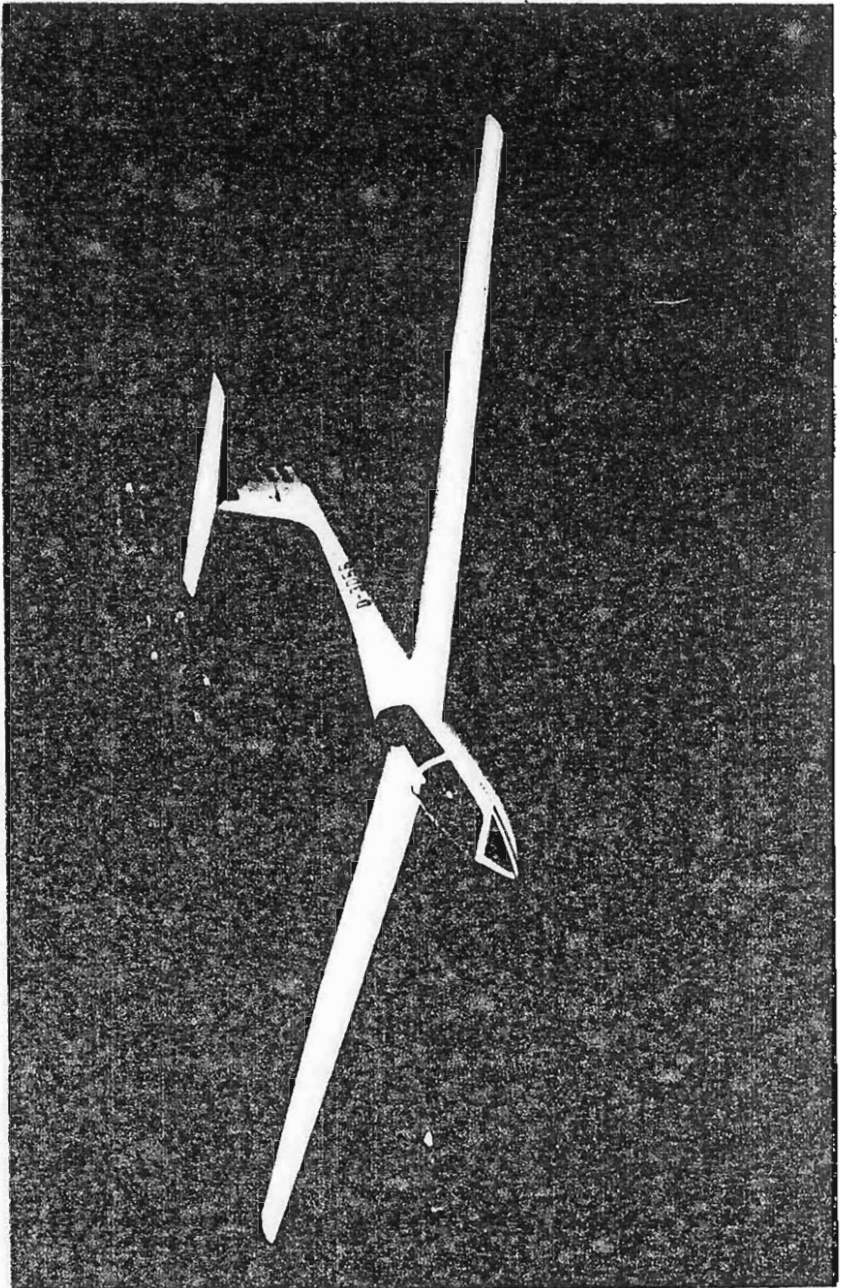

September 1981

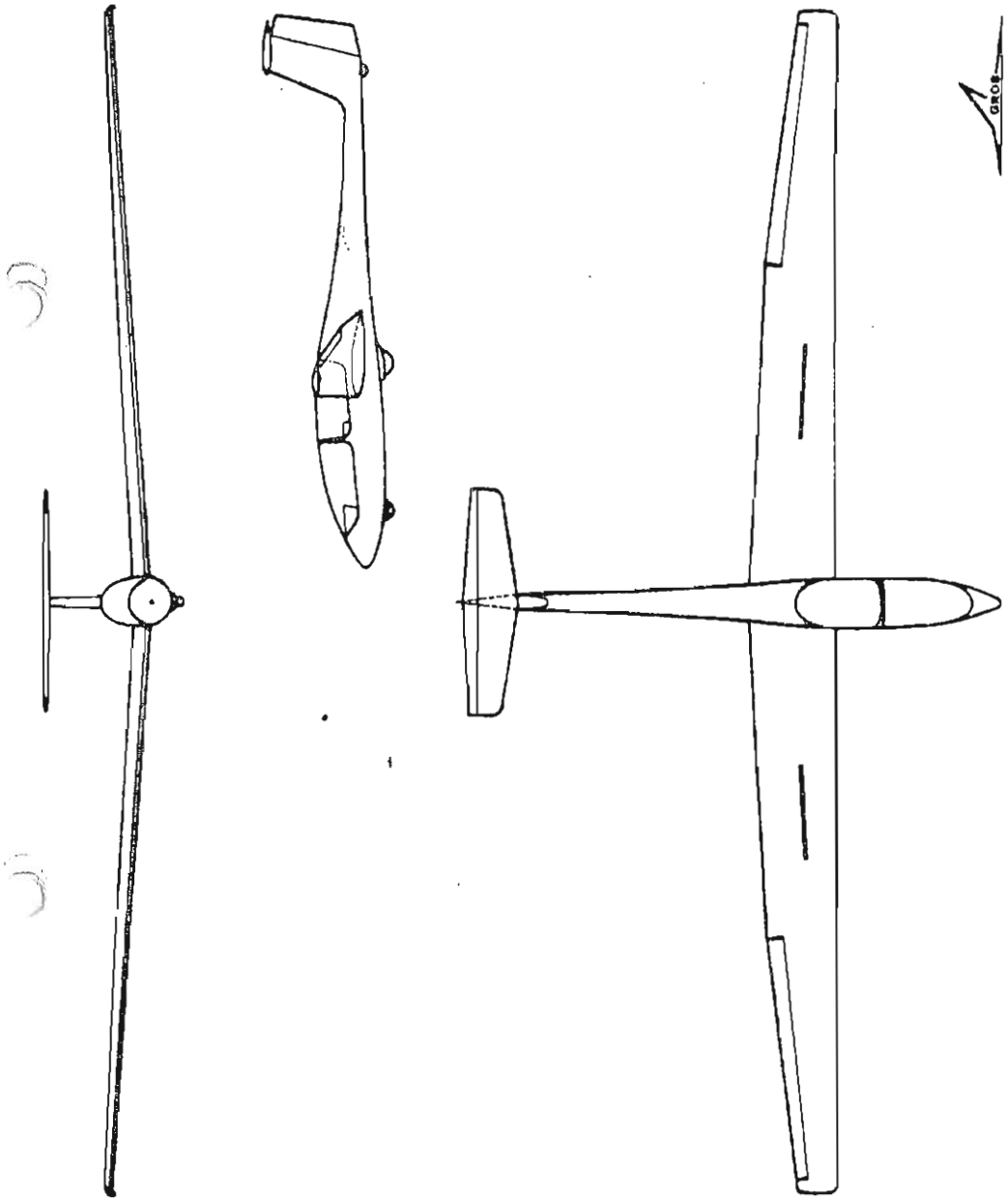

September 1981

If the fuselage reinforcement according to OSB 315-66 had not been performed the following is applicable:

The glider GROB G 103A "TWIN II ACRO" is derived from the GROB G 103 "TWIN II". Due to structural reinforcements the "TWIN II ACRO" is approved in the category "Acrobatic". According to MSB 315-65 only "simple aerobatics" (Loop, Turn, Lazy Eight, Chandelle, Spin) is approved (refer to II.2 and IV.9)

The

Flight Handbook for Aerobatics
GROB G 103A "TWIN II ACRO"
Edition February 1984
LBA approved

is invalid according to MSB 315-65 and must be removed from the Flight Handbook.

If the fuselage reinforcement according to OSB 315-66 had been performed the following is applicable:

The glider GROB G 103 A "TWIN II ACRO" is derived from the GROB G 103 "TWIN II". Due to structural reinforcements the "TWIN II ACRO" is approved and certified for acrobatics in conjunction with the following valid operating instructions:

Flight handbook for aerobatics,
GROB G 103 A " TWIN II ACRO",
edition February 1984,
LBA approved.

These operating instructions must be added to the flight manual and contain special instructions valid for acrobatic operations. Main modifications to the "normal" flight manual are contained in the following sections:

- Airworthiness group (II. 1) page 6
- Permitted operating conditions (II. 2) page 6
- Minimum equipment (II. 3) page 6
- Maximum speeds (II. 4) page 7
- Flight envelope (II.5) page 7
- Load scheme (II. 8) page 8

The following items were modified in the maintenance handbook with respect to the acrobatic version:

- Weights and moments of control surfaces (VI)

References to the flight handbook for aerobatics are shown on the affected pages of the "standard" flight manual.

1.5 Description

The "TWIN II" is a high performance two seater sailplane with a T-tail, fitted with a nonretractable tandem undercarriage and upper surface airbrakes.

This sailplane is manufactured using the latest techniques in Industrial Glass fibre construction.

It is designed for training, high performance and simple aerobatic flying.

Technical Data:

Span	17.5 m (57.4 ft.)	Wing Area	17.8 m ²
Length	8,18m (26,8ft)		(191.6 ft. ²)
Height	1,55m (5,1ft)	Maximum Flying Weight	580 kg
Aspect			(1279 lbs)
Ratio	17.1	Maximum Wing Loading	32,6 kg/m ²
			(6,68 lbs/ft. ²)

II. Operating limitations:

II. 1 Airworthiness Group

Certification Basis: 14 CFR Sections 21.23 and 21.29 effective 1 February 1965; and Joint Airworthiness Requirements for Sailplanes and Powered Sailplanes (JAR-22), dated 1 April 1980.

II. 2 Permitted operating conditions.

The plane is licensed for:

1. VFR Day
2. Simple Aerobatics (Loops, Stall turns, Lazy eight, Chandelle and Spin).

II. 3 Minimum equipment

1. 2 Air speed indicators reading to 300 km/hr (162 kts, 187 mph)
2. 2 Altimeters.
3. Full Harness Straps in front and back cockpit.
4. Parachute or back cushion at least 7 cm (3 inch) thick for each occupant.
5. Loading limit plaque in front and back cockpit.
6. Flight Limits plaque.
7. Flight Manual

17 th march 1982



17. März 1982

II. 4 Maximum Speeds

Maximum permitted speed in calm air	$V_{NE} = 250 \text{ km/h (135 kts, 155 mph)}$
Maximum permitted speed in rough air	$V_B = 170 \text{ km/h (92 kts, 105 mph)}$
Manoeuvring speed	$V_M = 170 \text{ km/h (92 kts, 105 mph)}$
Maximum winch launch speed	$V_W = 120 \text{ km/h (65 kts, 74 mph)}$
Maximum Aerotow speed	$V_T = 170 \text{ km/h (92 kts, 105 mph)}$

Conditions in rough air are similar to those encountered in rotors, clouds, whirlwinds and when overflying mountain ranges.

Manoeuvring speed is the maximum speed at which full control deflections may be used. At maximum speed (V_{NE}) the control deflections should be restricted to 1/3 of the full range.

True airspeed is higher than indicated airspeed at altitude. V_{NE} decreases according to following table.

Altitude (ft)	0-6500	10000	13000	16500	19000
V_{NE} (indicated knots)	135	128	121	115	109
(indicated km/h)	250	237	225	213	202

Air speed indicator markings

77-170 km/h=42-92 kts=48-105 mph	- Green arc (normal range)
170-250 km/h=92-135 kts=105-155 mph	- Yellow arc (caution range)
at 250 km/h=135 kts=155 mph	- Red line (max. Speed)
at 95 km/h=51 kts=59 mph	- Yellow triangle
	(recommended minimum appr. speed)

Installation Errors

The airspeed indicator must be connected to the following sources: Pitot head in the tail fin, static vents side of the fuselage between the two seats.

Using a calibrated ASI the position error is not greater than $\pm 2 \text{ km/h}$ or 1 kt or 1.2 mph. A calibration curve is therefore not necessary.

II. 5 Flight envelope.

The sailplane design limit load factors are as follows:

At manoeuvring speed + 5.3 — 2.65

At V_{NE} + 4.0 — 1.5

(Brakes closed and calm air)

17 th march 1982

 *Perich*
17. März 1982

II. 6 Weight limits

Empty weight about 380 kg (837,7 lbs)
 Maximum flying weight . . 580 kg (1278,67 lbs)
 Maximum permitted weight of non lifting parts 400 kg (881,84 lbs)

II. 7 Centre of gravity position

The approved range of centre of gravity positions during flight is 260 mm (10.24 inches) to 460 mm (18.11 inches) behind the datum line, equivalent to 24.7% to 43.6% of the M.A.C. of the wing.

A/c attitude: incidence board of 600:24 angle.
 The datum line is the front edge of the wing at the wing root.

The approved centre of gravity range does not get exceeded by the payload distribution specified in the loading plan II. 8.

The exact position of the centre of gravity at flying weight can be calculated according to VI- 5.

II. 8 Load scheme „TWIN II“

Minimum load in the front seat for all flight	70 kg (154 lbs)
Maximum load in the front seat	110 kg (242 lbs)
Maximum load in the back seat	110 kg (242 lbs)
Maximum load in the baggage compartment	10 kg (22 lbs)

The maximum flying weight of 580 kg (1278,67 lbs) must not be exceeded.

Trim weights must be used at the suspensions in front of stick bulkhead to compensate if the front seat load is lower than 70 kg (154 lbs). See page 14.

16th june 1982

 25. JUN. 1982

II. 9 **Tow hooks** and cable length

For Aerotow: Nose hook "E 75" with modification 1-79.

For Winch launch: Safety back release hook "G 72" or "G 73".

Minimum aerotow cable length 40 m (130 ft)

Minimum launch cable length 600 m (1970 ft)

II. 10 **Weak link strength**

Winch launch and aerotow max ~~754~~ daN , max ~~1662~~ lbs

II. 11 **Tire Pressure**

mainwheel	6.00-6	2,5-2,8	bar
nosewheel	260x85	2,5	bar
tailwheel	210x65	2,5	bar

II. 12 **Crosswinds**

The maximum crosswind component approved for take off and landing, is 20 km/h (11 kts, 12 mph).

16th june 1982



Perin
25. Aug. 1982

II.13. Placards, control markings and instrument markings

Maximum flying weight	580kg 1280lbs			
Airspeed limits		km/hr	knots	mph
Never exceed	V_{NE}	250	135	155
In Rough Air	V_B	170	92	105
On Aerotow	V_T	170	92	105
On Winch or Auto Launch	V_W	120	64	74
Airbrakes Open	V_{DF}	250	135	155
Manoeuvring	V_A	170	92	105

both cockpits

Payload (Pilot and Parachute)		
Minimum in Front cockpit	70kg	154 lb
for all flight		
Less must be compensated with ballast secured in the seat		
Maximum load front	110kg	242 lb
The maximum weight must not be exceeded		

both cockpits

Simple aerobatics air speeds			
Recommended entry speed	km/hr	knots	mph
Loop	180	97	111
Stall turn	180	97	111
Spin	80	43	50
Chandelle	170	92	105

Required placards (front and back cockpit)



17. März 1982

Altitude (ft)	0-6500	10 000	13 000	16 500	19 000
VNE (KIAS)	135	128	121	115	109

near speed ind.

both cockpits

Check before launch

Full and free movement of controls?

Parachute secured?

Straps tight and locked?

Pedals adjusted and locked?

Brakes closed and locked?

Trim correctly adjusted?

Altimeter adjusted?

Canopy locked?

Cable on correct hook?

Beware: - Crosswind! - Cable break!

Front cockpit

Canopy Joltion and Emergency Exit

- Pull red handles on right and left of canopy fully back together
- Push canopy up and away with the left hand
- Release safety harness
- Stand up and get out over left or right side depending on the altitude
- When using a manual parachute grip release and pull firmly to full extent after 1-3 seconds

By Canopy release front and back

Tire Pressure
36 PSI 2,5 atm

mainwheel
nosewheel
tailwheel

16th June 1982



[Signature]
20. JUN. 1982

Elevator quick lock connected
Markings notice
Rotating knob turned in
Tailplane secured (cover closed)

Rudder fin

Baggage maximum

22 lbs 10 kg

Baggage compartment

**Dont push or
lift here**

Rudder

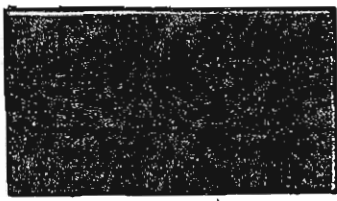

near magnetic direction
indicator

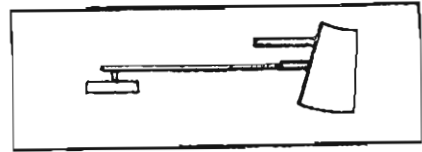

**Total energy
compensation tube**

17 th march 1982

 *Peri*
17. März 1982

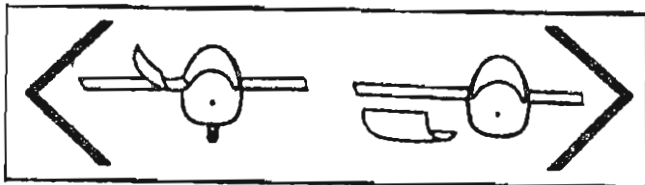

**Canopy open
Canopy jettison**

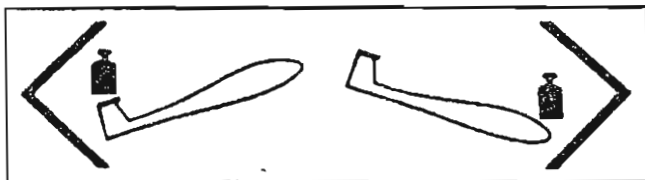

Trim

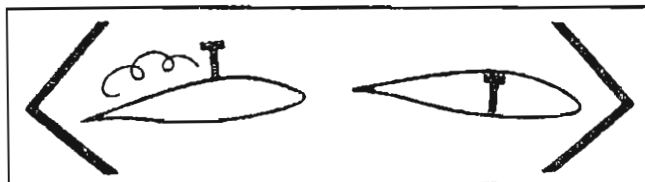

Airbrakes

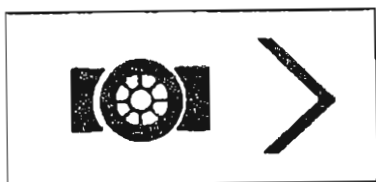

Wheelbrake

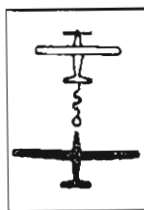

**Cable
release**



Pedal adjustment
Top right of front
instrument panel



Air-vent
Top left of front
instrument panel

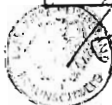

TRIM WEIGHTS				
Pilotsweight including parachute	kg	55-62,4	62,5-69,9	70-110
	lbs	121-137	138-153	154-242
Number		2	1	0
1 Trim weight: 5,6kg (12,3lbs)				

front cockpit

Labels and Markings outside of the fuselage

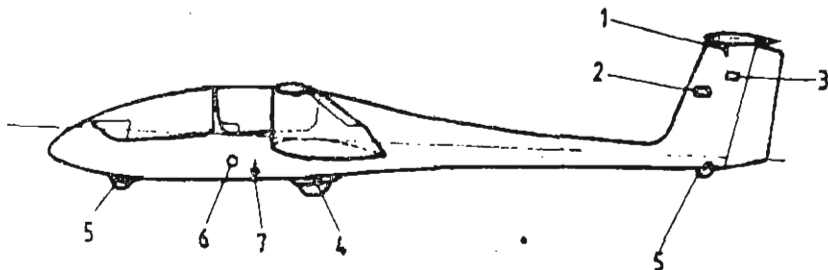

1. Marking controlling the correct rigging of the tailplane.
2. Label for the total energy tube.
3. Label for tailplane security
4. Label for tyre pressure
5. Label for tyre pressure
6. Red ring round the static pressure port
7. Marking to find the belly hook

16th june 1982



Perle
25. Aug. 1982

ASI Markings

mph	Speed		Mark	Significance
	knots	km/h		
48-105	42-92	77-170	Green Arc	Normal range of flying speed
105-155	92-135	170-250	Yellow Arc	Range of flying speeds to be used with care
at 155	135	250	Radial Red Line	Maximum Speed
at 59	51	95	Yellow Triangle	Minimum recommended landing speed at full load

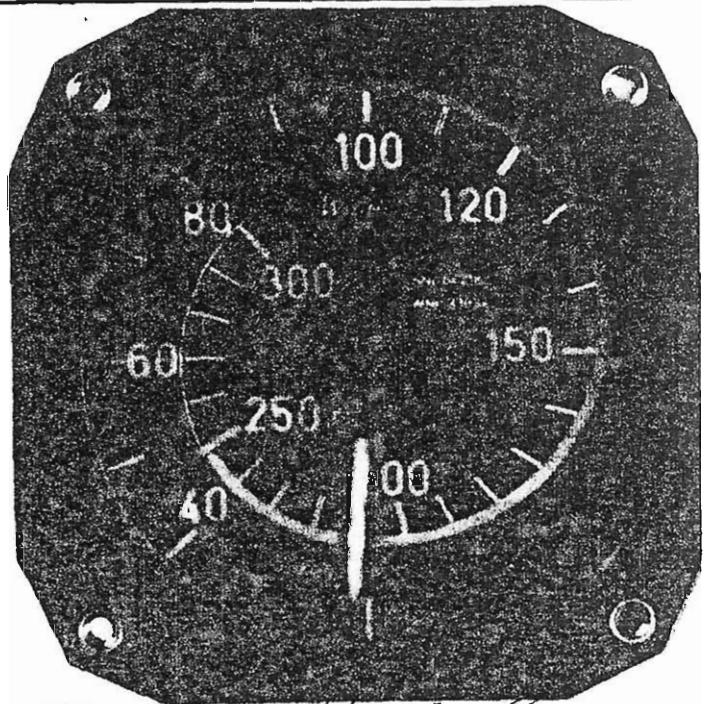

17 th march 1982

Perth
17. März 1982

III. Emergency procedures

III. 1. Recovery from the spin

Recovery spin can be accomplished by the standard recovery procedure:

- Full opposite rudder
- Neutralize stick
- Ailerons should be neutral
- When rotation stops neutralize rudder and pull out gently,

III. 2. Emergency canopy jettison and exit

- Pull red handles on right and left of canopy full back simultaneously.
- Push canopy up and away with the left hand.
- Release safety harness.
- Stand up and get out over left or right side depending on the attitude.
- When using a manual parachute grip release and pull firmly to full extend after 1-3 seconds.

III. 3. Miscellaneous

Flying in rain, iced wings

There is a noticeable deterioration of flying characteristics by wet or lightly iced wings, which raises the stall speed by about 6 knots:

Increase take off and approach speed by 6 knots.

Wing dropping

If a wing drops in a turn or straight flight, leave the stick neutral and apply rudder against the direction of rotation.

Groundloops

The aircraft is not prone to ground loop in take off, If one wing touches the ground or the aircraft changes direction by more than 15 degrees, release cable immediately.



Reinhold
17. März 1962

IV. Normal procedures

VI. 1. Cockpit and controls

Front Seat.

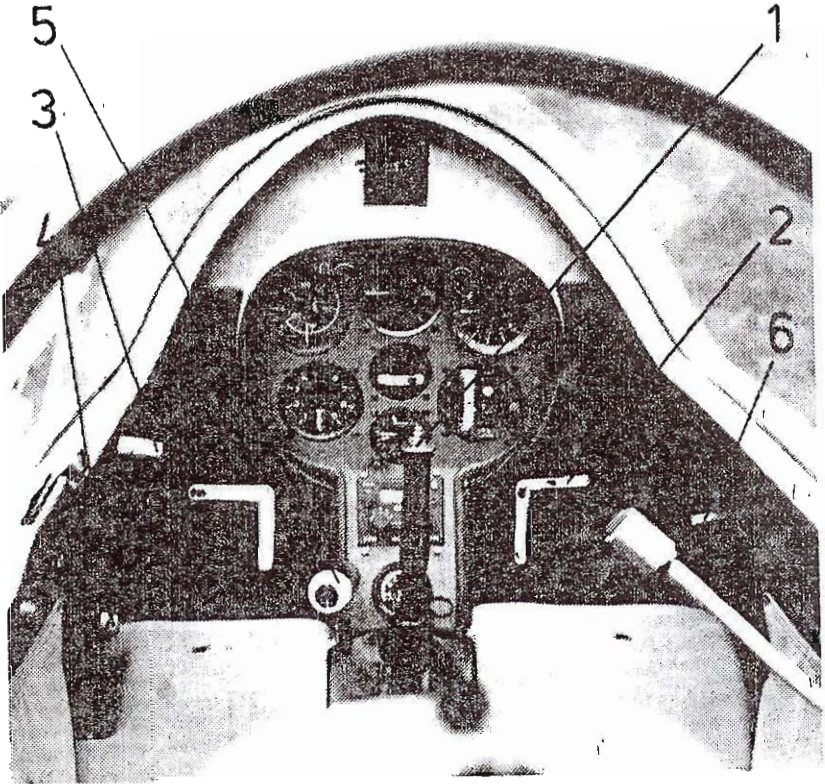

- | | | | |
|---|-------------------------------|---|-----------------|
| 1 | Stick | 5 | Release knob |
| 2 | Rudder pedals | 6 | Canopy jettison |
| 3 | Airbrake lever and wheelbrake | | |
| 4 | Trim lever | | |

Ventilator top of instrument panel left side.

Rudder pedal adjustment top of instrument panel right side.

16th June 1982



25. AUG. 1982

Standard instrument positions (front panel)

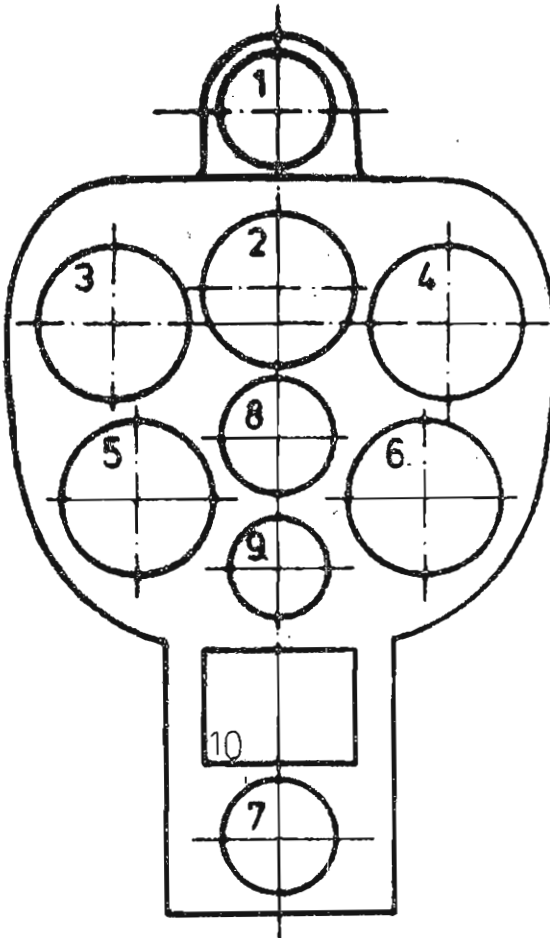

- 1 Magnetic compass
- 2 Electrical vario indicator (optional)
- 3 Airspeed indicator
- 4 Variometer
- 5 Altimeter
- 6 Electrical vario control (optinal)
- 7 G-Meter or variable
- 8 Ball
- 9 Temperature (outside) or variable
- 10 Radio

17 th march 1982



17. March 1982

Rear seat

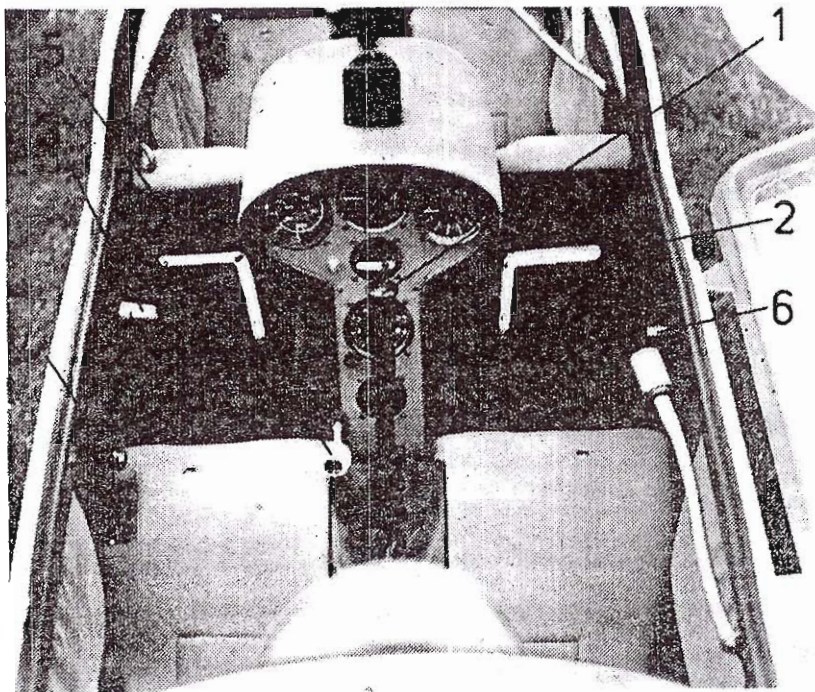

- | | | | |
|---|-------------------------------|---|-----------------|
| 1 | Slick | 4 | Trim lever |
| 2 | Rudder pedals | 5 | Release knob |
| 3 | Airbrake lever and wheelbrake | 6 | Canopy jettison |

16th june 1982



Peri
25. Aug. 1982

Standard instrument positions (rear panel)

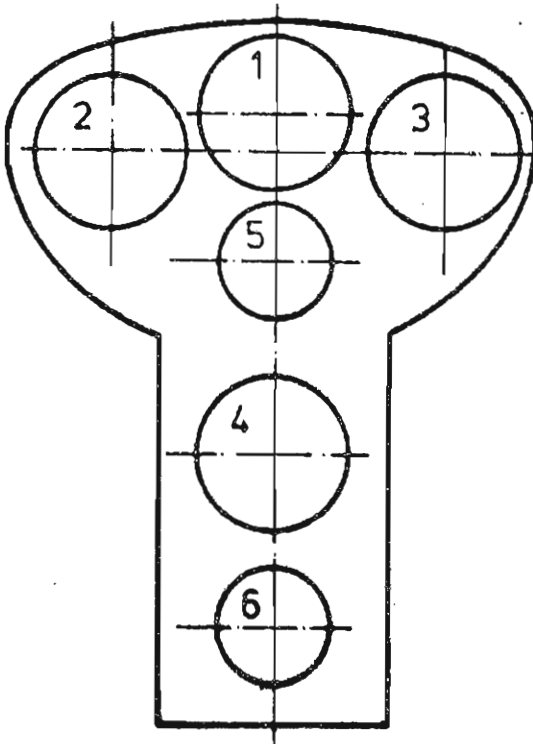

- 1 Altimeter
- 2 Airspeed indicator
- 3 Variometer
- 4 Electrical vario (optinal)
- 5 Ball
- 6 Variable

17 th march 1982



Perin

17. März 1982

IV. 2 Daily preflight inspection

1.
 - a) Open canopy.
 - b) Check the 4 wing fastenings inside the fuselage if locked.
 - c) Visually check all controls inside the cockpit.
 - d) Check for foreign bodies.
 - e) Test controls for full and free movement.
 - f) Check tire pressure 2.5 – 2.8 atm. = 35.6 — 39.8 PSI
 - g) Check condition of both hooks.
 - h) Check functioning of releases and wheelbrake.
2.
 - a) Check top and bottom of wing for damage.
 - b) Check ailerons for condition, freedom of movement and play.
 - c) Check airbrakes for condition, locking and fit.
3. Check fuselage for damage especially on the underside.
4. Check tail unit for correct assembly and that safety lock is in position.
5. Check condition of the tailskid.
6. Check the pitot tube, total energy venturi and static vents are clean.
7. Repeat step 2 for right wing.
8. Check static vents.

After heavy landings or excessive flight loads the entire glider should be checked. The wings and tailplane should be removed for these checks and if any damage is found an inspector should be consulted. The plane should not be flown before any damage is repaired.

17 th march 1982



Reinhold
17. März 1982

**Preflight Inspection Checkpoints
compare IV.-2**

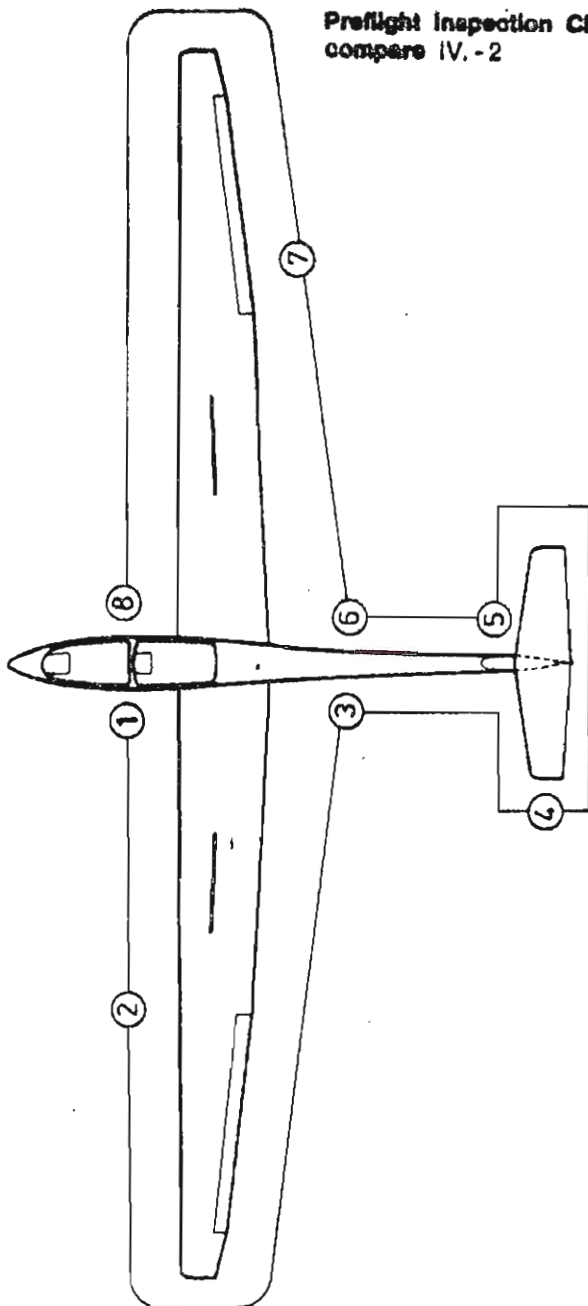

IV. 3 Control checks before take off

1. Check all controls for full and free movement.
2. Check that the ballast limitations are being adhered to.
3. Check safety straps and parachute are firmly fastened.
4. Check altimeter is adjusted to zero or airfield height.
5. Check that transmitter is switched on and set to airfield frequency.
6. Check trim is neutral.
7. Check canopy is closed and locked.
8. Check airbrakes are closed and locked.
9. Rudder-pedals adjusted correctly and locked.

IV. 4 Take off

Winch launch

Trim lever should be in central position.

Maximum winch launch speed is 120 km/h (65 kts, 74 mph).

The glider has a release hook in front of the mainwheel.

Winch launches cause no difficulties at all allowed centre of gravity positions and wing loadings.

The plane has no tendency to balloon up or to swing on the ground.

One should push forward slightly on the stick below about 100 metres (330 ft.) in the case of fast launches from a powerful winch. When the cable slackens pull the release firmly to its limit.

Aerotow

Trim lever should be in central position.

Maximum aerotow speed is 170 km/h (92 kts, 105 mph).

Aerotow should preferably use the nose hook.

The recommended length of tow rope is 40 — 60 m (120 — 200 ft.).

The glider can be controlled with coordinated rudder and aileron using full movements if required.

There is no tendency to swing in a strong crosswind.

The glider can be lifted off at about 70 km/h (38 kts, 44 mph).

The glider lifts off without assistance at a speed of about 80 km/h (43 kts, 50 mph) if the stick is kept in the neutral position.

The yellow release handle is mounted on the instrument panel and must be pulled to its limit when releasing.

17 th march 1982



Peri
17. März 1982

IV. 5 Free flight

It is possible to fly the glider over the entire speed range in all altitudes.

Full control movements are only allowed up to the manoeuvring speed 170 km/h (92 kts, 105 mph). At higher speeds the controls should be used with the appropriate care.

IV. 6 Slow flying and stalls

The glider gives clear warning when about to stall by a distinct shaking of the elevator.

The stalling speed depends on the wing loading and the condition of the plane. The following are guidelines:

Single seater

Weight	Without Airbrakes	With Airbrakes
470 kg = 1034 lbs	66 km/h (36 kts, 41 mph)	75 km/h (40,5 kts, 47 mph)

Double seater

Weight	Without Airbrakes	With Airbrakes
580 kg = 1279 lbs	75 km/h (40,5 kts, 47 mph)	85 km/h (46 kts, 53 mph)

If the stick is pulled back further the glider goes into a controllable high rate of sink, during which rudder and aileron turns can be flown at up to 15 degrees of bank. When the stick is released the glider returns to a normal flying attitude immediately.

After the stick is pulled back quickly the glider pitches nose down and the bank can still be controlled with aileron.

IV. 7 High speed flight

There is no tendency for flutter to develop within the permitted speed range. Above 170 km/h (92 kts, 105 mph) control movements should be restricted to 1/3 of full range. The airbrakes limit the speed to under VNE in a 45° dive even at maximum flying weight.

17 th march 1982



Peris
17. März 1982

IV. 8 Simple Aerobatics

The glider is licenced for the following aerobatics

1. Loop

Entry speed	180 km/h (97 kts, 111 mph)
Maximum g	ca. 3 g
exit speed	ca. 180 km/h (97 kts, 111 mph)

2. Stall turn

Entry speed 180 km/h (97 kts, 111 mph)
 At 140 km/h (76 kts, 87 mph) slowly apply rudder.
 Shortly before the top apply opposite aileron.

Note: The stall turn is difficult to carry out because of the high moment of inertia. If a tailslide is accidentally initiated during the climb hold all controls in the centred position firmly.

3. Spin (possible in aft C. G. positions only)

Preparation. Decrease speed slowly to 80 km/h (43 kts. 50 mph) pull stick back and apply full rudder. Glider spins slowly. Rotation rate is one turn every 3 seconds with a height loss of about 80 m (262ft.) per turn. The glider has no tendency to turn into a spiral dive. Recovery : opposite rudder, neutralise stick and recover gently.

17 th march 1982



17. März 1982

4. Chandelle

Entry speed 170 km/h (92 kts, 105 mph)

Pull up to fly 90° bank turn. During turn decrease speed and exit from turn with rudder and aileron. Chandelle should be completed heading in opposite direction.

5. Lazy Eight

Entry speed 140 km/h (76 kts, 87 mph)

IV. 9 Approach and landing

Normal flying practice is to approach at 95 km/h = 51 kts. The airbrakes are sufficiently powerful for steep approaches. The use of brakes causes the glider to be slightly nose heavy, so that the glider holds the required speed by itself.

Caution note:

Fully extended the airbrakes increase the stalling speed: do not extend the airbrakes fully during the roundout to avoid heavy landings. Dont use the airbrakes to full extension during touch-down due to strong effect of the wheel-brake.

If the nosewheel touches the ground the direction can be controlled by rudder until 40 km/h (22 kts, 25 mph).

The side-slip is quite controllable and, if needed, this manoeuvre can be used for steeper approaches. It is effective by using a 15 degrees angle of side-slip and should be finished of a safe hight (98 km/h; 54 kts; 61 mph). Rudder effect reversal have not been observed.

17 th march 1982



17. März 1982

The temporary control force to overcome the force reversal or rudder lock is calculated approximately 5 to 6 daN (rudder pressure). The aileron does not change its force direction, rather it returns independently from the full deflected position.

Rudder lock can be relieved without pilot input on the rudder. After moving the aileron into neutral position, the Sailplane rolls out of the Slip into wing level position. Thereafter the rudder frees itself from the full deflected position and the force reversal is relieved. Using this method to end the Slip the Sailplane does not adopt unusual flight attitudes and deviates only slightly from its original flight course.

IV. 10 Storage

When the glider is stored the canopy should be locked. To tie down the wing, a rope can be pulled through the wing tip skids.

17 th march 1982



Peri
17. März 1982

V. Appendices

V. 1 Flight Performance

Flying weight	450(902)	580(1213)	kg (Ibs)
Wing loading	25,3(5,2)	32,8(6,7)	kg/m ² (Ibs/ft ²)
Best glide Angle	36,5	37,0	
at a speed of	95 (51)	105 (57)	km/h (kts)
Minimum sink	0,64(126)	0,70(138)	m/sec(ft/min)
at a speed of	80 (43)	85 (46)	km/h (kts)

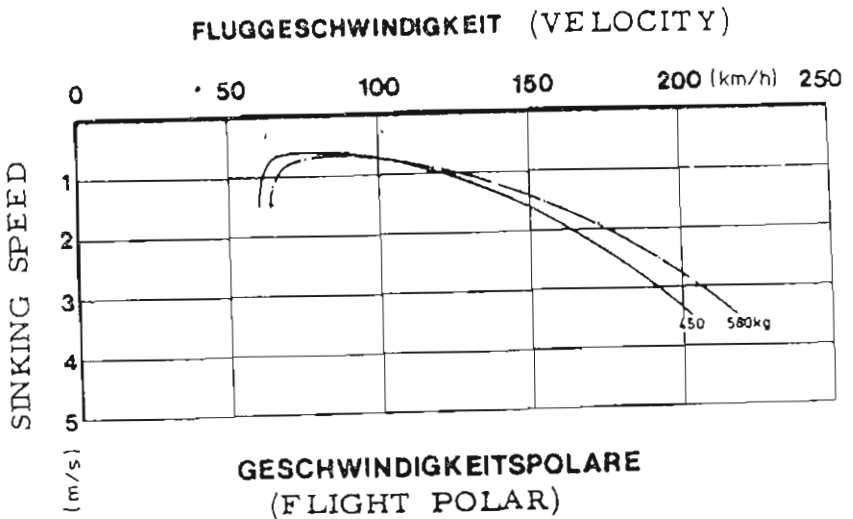

17 th march 1982



Peri
17. März 1982

V. 2 Determination of the Center of Gravity

The determination of the center of gravity is made with the glider supported on two scales at heights such that an incidence board of $600 : 24$ angle is set horizontal on the back of the fuselage. (Position on the fuselage see sketch at page 23). The reference plane lies at the front of the wing at the root. The distances a and b are measured with the help of a plumb line. The empty weight is the sum of the two weights G_1 and G_2 .

The Center of Gravity of the pilots is located:

1150 mm (45,8 inch) in front of the Datum Line (1. Seat)

40 mm (1,6 inch) behind the Datum Line (2. Seat)



17. März 1982

17 th march 1982

Procedure for determining C. of G. empty

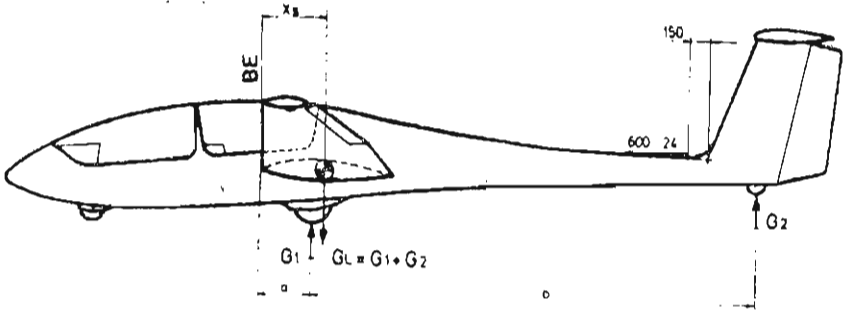

Datum Line: Front edge of the wing at the root rib.

Level Means: With a 800:24 Incidence Board set up horizontal on the top of the rear fuselage.

- Weight on main-wheel $G_1 =$ kg / lbs
- Weight on tail-skid $G_2 =$ kg / lbs
- Empty Weight $G_L = G_1 + G_2 =$ kg / lbs
- Distance to main-wheel $a =$ mm / inches
- Distance to tail-skid $b =$ mm / inches

Empty Weight C. of G.

$$X = \frac{G_2 \times b}{G_L} + a = \text{---} + = \text{mm/inches behind Datum Line}$$

The measurements to determine the empty weight, the empty weight C. of G. and the loading limitations must always be taken with the glider empty.

Conversion	from	to	multiply with
	kg	lbs	2,2
	mm	inches	0,0394

17 th march 1982



Perle
17. März 1982

If the limits of the empty weight C. of G. positions and the loading limitations chart are adhered to the C. of G. of the loaded glider will be within the permitted range.

Empty Weight		Range of C. of G. behind Datum			
kg	lbs	Forward		Aft	
		mm	Inches	mm	Inches
360	794	758	29.84	773	30.43
365	805	748	29.45	769	30.28
370	816	739	29.09	765	30.12
375	827	729	28.70	761	29.96
380	838	720	28.35	757	29.80
385	849	711	27.99	753	29.65
390	860	703	27.68	749	29.49
395	871	694	27.32	745	29.33
400	882	686	27.01	742	29.21

It should be noted that to make use of the maximum load the maximum admissible load for non-lifting parts must not be exceeded.

The weight of the non-lifting parts is the sum of the fuselage, tailplane and maximum load in the fuselage and must not exceed 400 kgs (882 lbs). Otherwise the maximum load permitted in the fuselage must be correspondingly decreased.

The Centre of Gravity should be recalculated after repair, repainting, the installation of additional equipment or when a period of 4 years has elapsed after the last weighing.

The empty weight, empty weight C. of G. position and maximum load, should be recorded after each weighing on page 9 of the Flight Handbook.

17 th march 1982



17. März 1982