

GROB-WERKE GMBH & CO. KG
Unternehmensbereich
Burkhart Grob Flugzeugbau
8939 Mattsies
Am Flugplatz
Telefon 08268/411
Telex 539 623

MAINTENANCE MANUAL GROB G 103

»TWIN II«

This Maintenance Manual is for U.S. registered gliders.

Registration: **N4446Y** Factory Serial No.: **3825**

Owner: _____

Published September 1981

Approval of translation has been done by best knowledge and judgement - in any case the original text in German language is authoritative.



Time 17 1985

Log of revisions

Revision No.	Pages affected	Description	LBA approval signature	Date
1	1, 1a, 4, 12, 13, 21	Modified elevator (TM 315-16)		April 1982
2	1, 1a, 4, 5, 6, 7, 8, 12, 13, 14, 15, 21, 22	Modification from serial no. 3730 (AM 315-12)		June 1982
3	1, 1a, 11, 12, 13	Modification from serial no. 3839 (AM 315-13)		Febr. 1984
4	1, 1a, 4, 4a, 7, 8, 8a, 9, 9a, 11, 12, 13, 13a, 16, 17, 20, 21, 21a	Automatic connection of elevator and spring trim system of serial no. 33879 and subsequent (AM 315-14/2)		Sept. 26 1984

All handbooks for GROB G 103 can be ordered at:

- Burkhart Grob Inc.
1070 Navajo Drive
Bluffton, OH 45817 / USA (419) 358-9015

- Grob-Werke GmbH & Co. KG
Unternehmensbereich Burkhart Grob Flugzeugbau
Flugplatz Mindelheim-Mattsies
8939 Mattsies, West Germany
(08268) 411

Sept. 26, 1984 (AM 315-14/2)

Pages included:

1	26th sept. 84	22	June 82
1a	26th sept. 84	23	Sept. 81
2	Sept. 81	24	Sept. 81
2a	Sept. 81	25	Sept. 81
3	Sept. 81	26	17th march 82
4	26th sept. 84	27	17th march 82
4a	26th sept. 84	28	17th march 82
5	June 82	29	17th march 82
6	June 82	30	17th march 82
7	26th sept. 84	31	17th march 82
8	26th sept. 84	32	17th march 82
8a	26th sept. 84	33	17th march 82
9	26th sept. 84		
9a	26th sept. 84		
10	Sept. 81		
11	26th sept. 84		
12	26th sept. 84		
13	26th sept. 84		
13a	26th sept. 84		
14	June 82		
15	June 82		
16	26th sept. 84		
17	26th sept. 84		
18	Sept. 81		
19	Sept. 81		
20	26th sept. 84		
21	26th sept. 84		
21a	26th sept. 84		

Sept. 26, 1984 (AM 315-14/2)

Contents	page
Log of revisions	1, 1a
Contents	2, 2a
I. Technical Data	3, 4
II. Description of components	5
1. Control Linkages	5, 6
Drawing of fuselage controls	7
Drawing of rudder control	8
Drawing of wing controls	9
2. Installation of Radio	10
3. Installation of Oxygen	10
4. Instruments specifications for basic equip-	10
5. Pressure tubing and connections to	
the instruments	11
III. Rigging Data	12, 13
IV. Rigging and derigging	14
1. Rigging	14, 15, 16
2. Derigging	17
3. Transport	17
V. Maintenance	18
1. Maintenance of glider	18
2. Maintenance of brakesystem	19, 20
VI. Weight and Moments of the control	
surfaces	21
VII. Checks	22
1. Daily checks	22
2. Checks in specific cases	22
3. Regular service	22, 23

MAINTENANCE MANUAL GROB G103 2a

VIII. Lubrications	24
X. General care	25
xi. Airworthiness limitations	26
1 Annual inspection checklist	27, 28, 29, 30
2 Inspection procedure for increase of service time	31, 32
3 Components with a limited life time	33

(LBA approved pages: 26 through 33)

I. Technical Data

Wings	
Profile Eppler	E 603
Span	b = 17,5 m 57.4 ft.
Area	F = 17,8 m ² 191.6 sq. ft.
Aspect Ratio	17,1
Ailerons	
Span	b _{QR} = 3,65 m 12 ft.
Chord inner	tl = 0,208 m .68 ft.
outer	ta = 0,105 m .34 ft.
Area	F _{QR} = 1,14 m ² 12.27 sq. ft.
% of Wing area	6,40 %
Fuselage	
Length	l = 8,18 m 26.8 ft.
Width of cockpit	b = 0,71 m 28 inches
Height of cockpit	h = 1,02 m 40 inches
Height of tailplane	h = 1,55 m 5.09 ft.
Surface area ca.	F = 13 m ² 139.94 sq. ft.
Fin	
Height	h = 1,3 m 4.27 ft.
Area	F = 1,37 m ² 14.75 sq. ft.
Aspect Ratio	1,23
Chord bottom	tu = 1,25 m 4.1 ft.
top	to = 0,86 m 2.82 ft.
Rudder	
% of Fin	F = 3,70 %
Area	-0,505 m ² 5.44 sq. ft.

Tailplane (beginning from s/n 33879)
(see also table at page 4a)

Span = 3.39 m 11.12 ft.
 Area = 2.18 m² 23.5 sq. ft.
 Aspect Ratio = 5.3
 Chord inner = 0.824 m 2.70 ft.
 Chord outer = 0.46 m 1.51 ft.

Elevator (beginning from s/n 33879)

Area = 0.61 m² 6.56 sq. ft.
 Chord inner = 0.24 m 0.79 ft.

Airbrakes (Grob System)

Area (Each) = 0.504 m² 5.425 sq. ft.
 Span = 1.4 m 4.59 ft.
 Height = 0.18 m 7.1 inches

Weights

Empty weight ca. 380 kg 838 lbs.
 Load Maximum 200 kg 441 lbs.
 1. Seat 110 kg 242 lbs.
 2. Seat 110 kg 242 lbs.
 Baggage ca. 10 kg 22 lbs.
 Load Minimum (1. Seat) 70 kg 154 lbs.
 Maximum Flying Weight 580 kg 1279 lbs.
 Load% of Flying Weight 36 %
 Wing Loading 2.5, 3-32, 6 kg/m² 5.18-6.68 lbs./sq. ft.
 Maximum weight of non-lifting parts 400 kg 882 lbs.

Table of technical data of tailplane of serial numbers before.

Serial number	from		G 103 „Twin II“		G 103 A „Twin II Acro“	
	through	optional	3501	3730	3544 K	3730 K
Tailplane						
Span	b	m	3.3	3.3	3.39	3.3
	F	m ²	2.1	2.14	2.18	2.14
Aspect ratio	-		5.1	5.1	5.1	5.1
	ti	m	0.805	0.82	0.82	0.82
Chord inner	ta	m	0.46	0.47	0.46	0.47
	outer					
Elevator						
Area	F	m ²	0.55	0.60	0.61	0.60
	-	%	26.4	28.0	28.0	28.0
Trim tab						
Span	b	m	0.95	0.95	(1)	0.95
	F	m ²	0.08	0.095	0.7	0.7
Modification	No.		AM	AM	AM	AM
			315-8	315-16	315-12	315-10
				(2)		(2)

All measurement in m or m² (1 m = 3.28 ft.; 1 m² = 10.76 sq. ft.)
 - The data was valid for the mentioned serial numbers when leaving factory. There might be deviations after major repairs.
 - Some technical data are corrected compare with handbooks before.
 - See also rigging data of elevator and trim tab at page 13 a.
 (1) Without trim tab but with spring system for trimming
 (2) Beginning from s/n 3839 (K) elevator with V-Section in the middle.
 26th Sept. 1984 (AM 315-14/2)

II. Description of Components

II.1 Control Linkages

The control of the TWIN II is designed as a push-rod system. The stick, bellcranks and horns are made from steel tubs or aluminium, the pushrods are made of aluminium tubing.

Elevator

The control stick force is transferred from the control stick via the stick mounting frames to the elevator pushrod. The two control sticks are firmly connected. The rear control stick is detachable and held in place by a butterfly. Three elevator pushrod leads from the rear stick to the elevator horn in the side fin. A connection rod with snap fastener drives the horn in the elevator. All the components in the fuselage may be dismantled. The elevator horn is laminated into the elevator. Stops for the elevator are situated on both stick mounting frames under the seats.

Aileron controls

The lateral control force is transferred from the control stick via a short connection rod to the aileron control bellcrank on the side of the fuselage. The aileron control bellcranks for both control sticks are rigidly connected by means of 2 pushrod. Pushrods lead from the rear crank via an intermediate crank at the wheel box to the lower connection to the linkage assembly in the bottom of the fuselage. The aileron control connection and the pushrods in the wing are driven via the upper crank of the linkage assembly. The outboard aileron control differential lever in the wing drives the aileron directly via a short pushrod. All components of the aileron control system in the fuselage may be dismantled. The aileron control differential lever and the pushrod in the wing may only be dismantled through an opening made in the GFK skin. Stops for the aileron linkage are present on both control sticks.

16th June 1982

Rudder Linkages

Control cables lead from the front pedal mounting which can be adjusted in steps. The cables lie on the inside of the pedals and are routed to the bell crank of the rear pedal unit. The complete rudder linkage system may be dismantled. The stops for the rudder and the bellcrank are mounted near the rear pedal mounting.

16th June 1982



Steuerung im Rumpf
Fuselage controls:
(valid from s/n 33879)
GROB G 103

26th Sept. 1984
(AM 315-14/2)

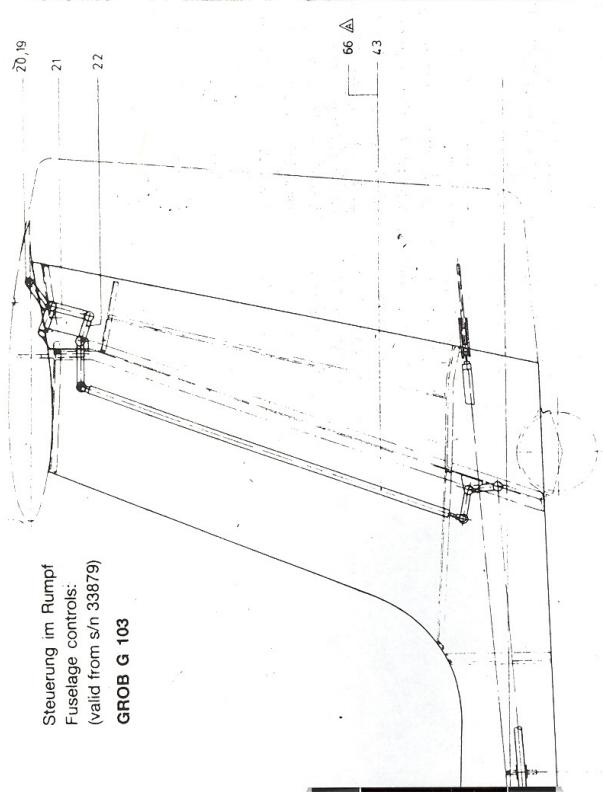

Steuerung im Rumpf
Fuselage controls:
(valid from s/n 33879)
GROB G 103

23

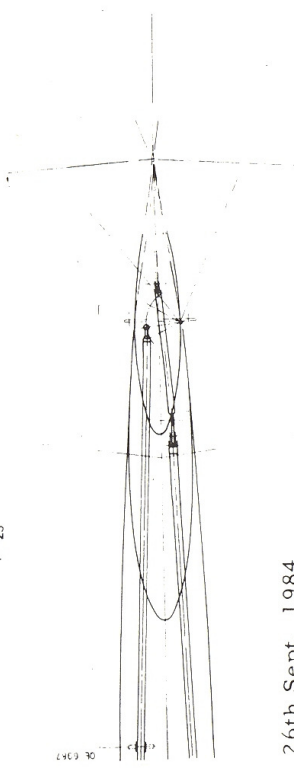

26th Sept. 1984
(ÄM 315-14/2)

Parts list: Controls in the fuselage

Lfd.-Nr.	Designation	Part number
3	Stick assembly front	103 B - 4401
4	Stick assembly rear	103 B - 4410
5	Pedal unit	103 B - 4420
6	Airbrake-trim unit	102 C3 - 4230
7	Airbrake-trim unit	103 B - 4412
8	Rudder lever	103 B - 4430
9	Reversing right	103 B - 4431
10	Reversing left	103 B - 4434
12	Airbrake reversing	103 B - 4437
15	Rudder. Swing	103 B - 4441
17	Aileron lever	103 B - 4454
18	Airbrake lever	103 B - 4451
19	Elevator connector right	103 B - 4768
20	Elevator connector left	103 B - 4767
21	Lever	103 B - 4765
22	Lever	103 B - 4763
23	Lever	103 B - 4761
24	Pedal unit front	103 B - 4778
31	Aileron rod 1	102 C3 - 4351
32	Aileron rod 2	103 B - 4552
33	Aileron rod 3	103 B - 4553
34	Aileron rod 4	103 B - 4554
35	Aileron rod 5	103 B - 4555
36	Connector right	103 B - 4556
37	Connector left	103 B - 4557
38	Elevator rod 1	103 B - 4560
39	Elevator rod 2	103 B - 4561
40	Elevator rod 3	103 B - 4562
41	Elevator rod 4	103 B - 4563
42	Elevator rod 5	103 B - 4564
43	Elevator rod 6	103 B - 4765
44	Airbrake rod 1	103 B - 4570
45	Airbrake rod 2	103 B - 4571
46	Airbrake rod 3	103 B - 4572
47	Airbrake rod 4	103 B - 4573
48	Airbrake rod 5	103 B - 4574
49	Trim rod 1	103 B - 4785
50	Trim rod 2	103 B - 4786
51	Trim rod 3	103 B - 4581
54	Rudder rod 1	103 B - 4586
55	Rudder rod 2	103 B - 4587
56	Rudder rod 3	103 B - 4247
58	Connector right	103 B - 4558
59	Connector left	104 - 4322
64	Rudder rod 3	103 A - 4592
65	Elevator rod 5	103 A - 4590
66	Elevator rod 6	103 A - 4794
70	Trim unit	103 B - 4780

26th Sept. 1984 (ÄM 315-14/2)



Querruder- und Bremsklappensteuerung
im Flügel

Wing controls: Ailerons
and Air brakes

GROB G 103
(valid from s/n 33879)

Parts List: Controls in the wing unit

Aileron control system

Ref.-No.	Designation	Part number
1	Aileron lever left	103 B - 4737
	Aileron lever right	103 B - 4738
3	Connection lever left	103 B - 4735
	Connection lever right	103 B - 4736
5	Aileron rod VI	103 B - 4113
6	Aileron rod VII	103 B - 4115
7	Pillow block	109 - 2053
8	Pillow block	102C3 - 2054
9	Control rod fork end	104 - 4297

Airbrakes control system

Ref. No.	Designation	Part number
1	Pivoted lever left	103 B - 4721
	Pivoted lever right	103 B - 4722
2	Locking lever left	103 B - 4723
	Locking lever right	103 B - 4724
4	Airbrake rod V	103 B - 4117
5	Airbrake rod IV	103 B - 4118
6	Airbrake rod III left	103 B - 4119
7	Airbrake rod III right	103 B - 4120
9	Pillow block	109 - 2053
10	Pillow block	102C3 - 2054

26th Sept. 1984 (AM 315-14/2)

II. 2 Installation of Radio

The front instrument panel may be obtained in three layouts and can accommodate a rectangular instrument (80 x 80 mm or 146 x 47 mm) as well as 80 mm diameter instruments. The internal loudspeaker should be mounted on the rear instrument panel. "Swan neck" microphone booms may be mounted to the pilots right on the canopy frame. The shelf under the rear control linkage complex is prepared for fixing a battery. Drawings for the installation of the radio unit can be obtained on request.

II. 3 Installation of Oxygen

An Oxygen cylinder may be mounted behind the rear seat. Drawings for the installation of the Oxygen equipment can be obtained on request.

II. 4. Instruments specifications for basic equipment
Airspeed Indicator

The original certification was carried out using 2 Winter 6FMS4-2 Airspeed indicators.

A similar FAA approved airspeed indicator to meet TSO C 2 reading to 300 km/h (162 kts, 187 mph) may be used. (For example PZL PR-400 S).

Altimeter

The original certification was carried out using a Winter 4FGH 10 and a Winter 4 HM 6.

A similar FAA approved altimeter to meet TSO C 10 with a range to 35 000 feet may be used. (For example PZL W-12 S)

Magnetic Compass (compensated inside the glider)

The original certification was carried out using a Airpath C 2300.

A similar FAA approved magnetic compass to meet TSO C 7 may be used. (For example PZL BS-1)

September 1981

II.5 Pressure tubing and connections to the instruments
(two schemes of optional systems)

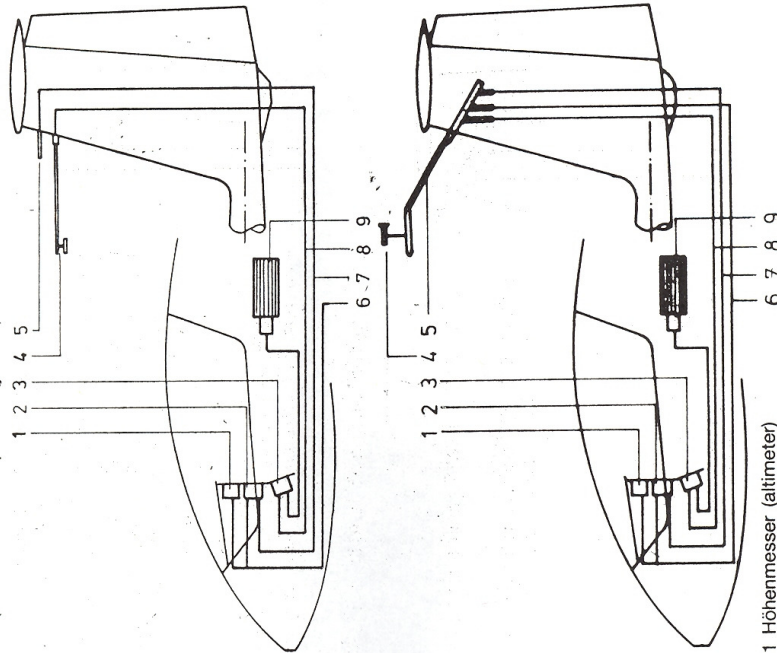

- 1 Höhenmesser (altimeter)
- 2 Fahrtmesser (air speed indicator)
- 3 Variometer (variometer)
- 4 Kompensationsdüse (total energy tube)
- 5 Pitot-Static-Rohr (pitot static tube)
- 6 Statischer Druck (static pressure) farblos (colourless)
- 7 Staudruck (pitot pressure) grün (green)
- 8 Düse (Totalenergy) rot (red)
- 9 Ausgleichsflasche (flask) blau (blue)

26th Sept. 1984 (ÄM 315-14/2)

III. Rigging Data (valid from s/n 33879)

Reference Line	Value	Tolerance
Wing - Incidence angle and the longitudinal axis of the fuselage	2° 30'	± 15'
Wing - Distance of line joining the wing tips from the reference line	0	± 40 mm (1.57 in)
Wing - Dihedral	3.5°	± 30'
Tailplane - Angle between the chord of the tailplane and the longitudinal axis of the fuselage	0	± 30'
Reference line	Front of the wing at the root rib	QE 2980 (117.32 in)
Control deflections (mm)	Upwards (right) Value Tolerance	Downwards (left) Value Tolerance
Alleron Starboard	90 ± 10	50 ± 8
Elevator	95 ± 8	74 ± 6
Rudder	233 ± 10	233 ± 10
Release Hook	Backrelease load 0.5 to 1 kg (1.1 to 2.2 lbs) Maximum pull to release 7 kg (15.4 lbs)	

(see also rigging data of tailplane at page 13a)

26th Sept. 1984 (ÄM 315-14/2)

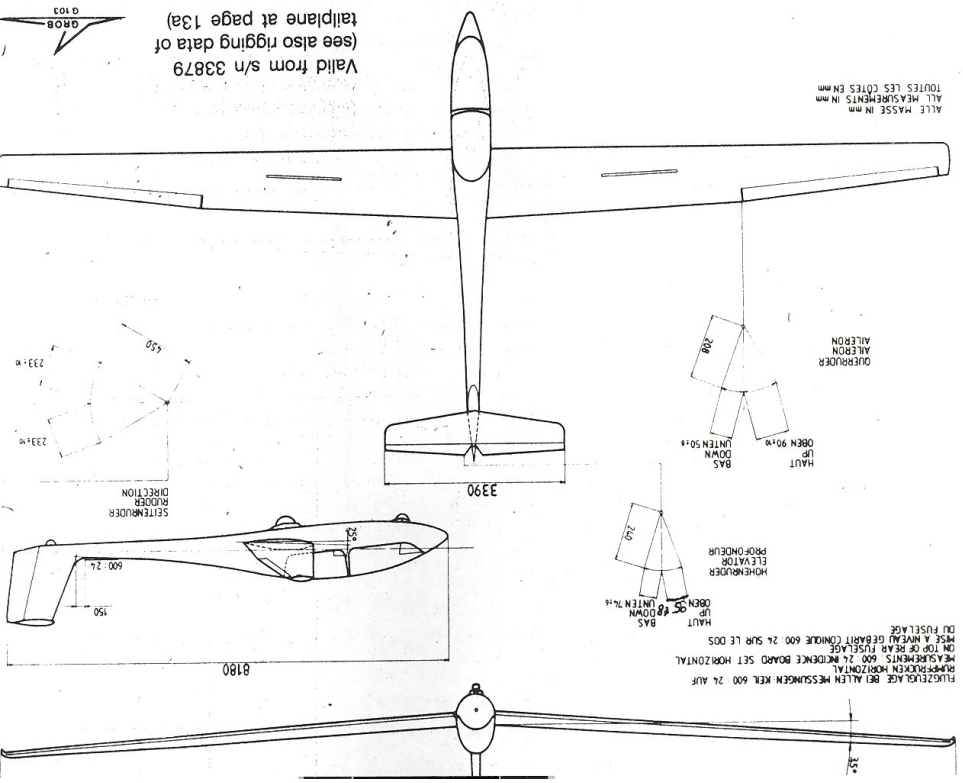

26th Sept. 1984 (AM 315-14/2)

Table of rigging data of elevator and trim tab of serial numbers before.

Serial number	G 103 „Twin II“				G 103 A „Twin II Arco“			
	from through	optional	3730 3839 3838	3839 3878	from 3544 K 3730 K 3839 K	3729 K 3838 K 3878 K 33879 K	97 97 97	95 95 95
Elevator (mm)	up-wards	97 ± 8	97 ± 8	95 ± 8	97 ± 8	97 ± 8	97 ± 8	95 ± 8
	down-wards	70 ± 5	76 ± 6	74 ± 6	74 ± 6	76 ± 6	74 ± 6	74 ± 6
Trim tab elevator in neutral position	measurement point	212	245	240	233	245	240	240
	up-wards	45 ± 5	70 ± 7	45 ± 5	54 ± 5	70 ± 7	45 ± 5	45 ± 5
Modification	down-wards	60 ± 5	70 ± 7	45 ± 5	72 ± 6	70 ± 7	45 ± 5	45 ± 5
	measurement point	96	116	90	116	90	116	60
	No.	AM 315-8	AM 315-16	AM 315-12 (2)	AM 315-13 (2)	AM 315-10	AM 315-12 (2)	AM 315-13 (2)
								AM 315-14 (2)

All measurement in mm (1 mm = 0.039 inch)
 - The data was valid for the mentioned serial numbers when leaving factory.
 - There might be deviations after major repairs.
 - See also technical data of tailplane at page 4 a.
 (1) Without trim tab but with spring system for trimming.
 (2) Elevator with V-Section in the middle.

IV. Rigging and derigging

IV. 1 Rigging

The fuselage must be held firmly in a horizontal position when rigging. It is recommended to use a fuselage stand or the trailer fittings are used.

The glider can be rigged by 4 people.

1. Wings

Unlock the 4 main wing fittings in the fuselage. Unlock the airbrakes on the wings. Guide the right wing into the fuselage. The safety catches on the fuselage fittings should now be released, and on gently moving the wing forward and aft it can be heard to snap into place. Next guide the left wing into the fuselage. Move the wing tips up or down so that the pin on the end of the spar stub is lined up with the appropriate hole in the opposite wing root and slide into place. Next release the safety catches on the left hand fuselage fitting and by gently moving the wing to and fro they too can be made to snap into place.

To secure the fuselage-wing linkage in the closed position the safety nut (1) must be turned into the threaded socket (2) so that the socket is pulled inboards against the red ring which is held by the guide pin (3).

16th june 1982

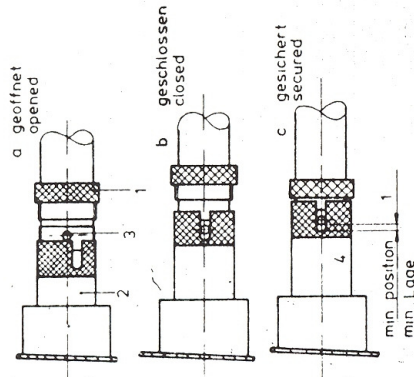

By moving the wings forward and aft strongly while turning the safety nut into the socket this linkage can be secured tight enough (4). The guide pin must not touch the end of the sbt in the socket.

Check: The socket must cover the red ring.
The safety nuts must be turned hand-tight.

In the closed but unsecured position (b) the wing bolt cannot be pulled out of the fitting.

The connecting rods can be connected by means of the quick lock fasteners through the inspection opening.

Having engaged the quick locks check that the safety pin cannot be moved without pressing it down. If it cannot be slid without pressing down when the controls are properly connected.

16th june 1982

Checks to be made after assembly

1. Check that the 4 main wing fittings are locked.
2. Check that aileron and brake quick-actions locks are properly located on the knobs.
3. Ensure that the tow hook is functioning correctly.
4. Test the operation of the wheelbrake and the tire pressure.
5. Check that the tailplane is securely seated and control the 4 markings.
6. Control: Surfaces movement free.

IV. 2. Derigging

Derigging is carried out in the opposite order and in this case it does not matter which wing is removed first. Excessive fore and aft rocking of the wing tips should be avoided.

IV. 3 Transport

We recommend the use of a closed trailer for transporting the glider. The parts must be carefully supported and secured so they cannot slide.

1. Fuselage

A fuselage trolley moulded to the shape of the fuselage and positioned in front of the main wheel. The minimum length of the trolley should be 400 mm and it can be attached to the wing fittings if required. The tail skid should be secured so that it cannot slide sideways.

2. Wings

The minimum length for the spar support should be 200 mm and should start at the face of the root rib. The mounting must be padded well with foam rubber or felt.

The mounting under the aileron inboard end should be a shaped mounting block with a minimum length of 300 mm and height of 400 mm. The mounting must be padded with felt.

3. Tailplane

Either horizontal on padded supports with the upper surface downwards and secured with straps or vertical supported on the leading edge in shaped mounting blocks.

Profile drawings are available for the manufacture of fuselage, wing and tailplane fittings.

3. Tailplane

Before assembly is commenced the front cover must be opened and the rotating wing bolt pulled out to the limit. It is important to ensure, that the larger opening of the conical crillings in the inner rings of the horizontal stabilizer spar bearing fall to the rear. The tailplane can be positioned on top of the fin so that the automatic elevator connector can attach. The tailplane can then be pushed back into the three pins. It is then necessary to tighten the wing bolt clockwise to secure the tailplane. The assembly is complete when the wing bolt is sufficiently tight that there is no play in any direction. The cover provides a safety measure as it can only be attached with the wing bolt horizontal. If necessary the wing bolt has to be turned a 1/4 turn to suit. Derigging is carried out in the opposite order and the wing bolt is turned anticlockwise and pulled fully out.

To control the correct mounting of the horizontal stabilizer it is important to ensure that the peaks of the mark-arrows at fin and elevator tabs face each other.

V. 2. Maintenance of Brakesystem
 The wheelbrake of the "TWIN" is a disk brake. When dismantling the Mainwheel for cleaning or greasing purposes, or changing the tire, unscrew Poly-stop nuts M8 and remove wheelaxle to the left. Then remove distance pipe (p 42x2) to the right. Distance bush = Distanzbüchse). Remove wheel downwards, clean all parts and grease before assemble again.

Changing of brakeshoes

- a) Remove the wheelcover.
- b) Loosen 1/4 inch screws (spanner size 11 mm) to take out brake. Do not remove brakepipe or you have to bleed again.
- c) Take off the two parts, on witch the brakelining are riveted on.
- d) Mount new brakelining with rivets, assemble in reverse order.
- e) Shape of brakelining.



Bleeding of brakesystem

- a) Mount transparent plastic pipe on bleedingscrew put other end of pipe in a container with brakefluid.
- b) Loosen bleeding screw, when brake via lever and brakezylinder pushes brakefluid trough the brake.
- c) Bleeding is complete when no more airbubbles can be seen in transparent plastic pipe.

V. Maintenance

V. 1. Maintenance of the glider

The entire surface of the glider is coated with weather resistant white polyester gelcoat.
 The greatest care should be taken in maintaining the fibre glass surface of the glider. Luke warm water should be used to wash off dust, grease, dead flies and other dirty marks. More resistant dirt should be removed by using a mild cleaning agent. Only special silicone-free preparations should be used in maintaining the painted surfaces. (1 Z-Spezialreiniger - D 2, Fa. W. Sauer and Co., 5060 Bensberg or Reinigungs polish Fa. Lesonal).

Although very resistant the glider should be protected as much as possible against rain and dampness. Water that has seeped in should be dealt with by storing the glider in a dry place, frequently turning over the dismantled parts.

The most effective way to clean the canopy is to use a special perspex cleaner but if necessary luke warm water can be used. A soft, clean cloth or chamols-leather should be employed to wipe the canopy down. Never rub perspex with anything dry.

The Safety harness should be regularly checked for damage and general wear. The metal parts of the harness should be frequently checked for corrosion.

Because of its position, the winch launch hook is susceptible to getting very grimy and muddy. It must therefore be frequently inspected for damage, cleaned and greased. When the seat-well is removed the hook can easily be taken out. Remove the connecting wire from the lever and take out the retaining screws. For reconditioning, the tow hook should be sent with the record card to the tow hook manufacturer, Tost. For further details the manufacturers manuals should be consulted.

The cables and pulley for the nose and belly hooks should be checked for wear during the yearly inspection.

The main wheel tyre pressure should be kept at 2.5 to 2.8 bar nose wheel and tailwheel 2, 5 bar

Remarks:

The ATE brakefluid DOT 3 (ambercoloured) is available in every shop for car parts. Standardized within Europe.

The master brake cylinder with the brake fluid reservoir is located under the baggage compartment or under the rear seat.

The marks for the lowest and highest level of the hydraulic brake fluid have to be observed.

VI. Weights and moments of the control surfaces

Control Surface moments (valid from s/n 33879)

The moments of the control surfaces must not exceed the following values:

Elevator	26.0 kg cm	+ 12%	4.2 kg ± 15%
Rudder	20.0 kg cm	± 10%	5.0 kg ± 10%
Aileron	12.0 kg cm	± 12%	6.0 kg ± 10%

(See also table at page 17a)

The moments must be measured with the control surfaces removed. To determine the moment $M = P \cdot r$ the surface should be mounted at the hinge line with the minimum friction possible. The force P can be measured, for example, using a letter scale. If these values are exceeded the mass balance should be increased. Before carrying out repairs which for example involve changing the mass balance on a surface the manufacturer or his repair agent should be consulted.

(1 kg = 2.20 lbs, 1 kg cm = 7.23 ft. lbs)

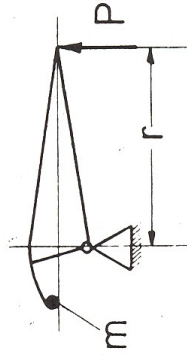

VII. Checks

VII.1. Daily checks

Daily checks and checks before launch: See Flight Handbook IV-2.

VII.2. Checks in specific cases.

After a heavy landing:

Check the undercarriage mechanism under the rear seat, check the undercarriage mountings in the wheel well, check the spar and root rib for white patches in the glassfibre reinforced plastics (GFK).

Check the wing fittings in the fuselage and the pins in the root rib.

Check all mounts of control surfaces.

After a Ground loop:

Check the undercarriage mounting, check the rudder controls rods and bellcranks behind the wheel well.

Check the GFK tube at the base of the fin.

Check the wing fittings in the fuselage and the connecting pins in the root rib.

Check the tail plane suspensions.

VII.3. Regular service

The following schedule of service should be carried out every 100 hours or at the annual inspection, whichever ever occurs first.

1. The entire glider should be checked for cracks, holes and bumps.
2. All fittings should be inspected for satisfactory condition (play scores and corrosion).
3. All metal parts should be examined for corrosion, cracks, deformation and if necessary reconditioned and freshly protected.
4. Check that there is no play in the wing and tailplane to fuselage fittings.
5. The control linkages (Bearings, stops, fittings, hinges and control cables) should be inspected and replaced if there is evidence of bending or corrosion.

16th June 1982

Table of weights and moments of the control surfaces of serial numbers before.

Serial number	G 103 „Twin II“		G 103 A „Twin II Acro“	
	optional 3501 3729	3730 3878	3544 K 33879	3730 K 3878 K 33879 K
Elevator (incl. trim tab)	Moment kg cm	33.5 + 12% - 20%	26.0 + 12% - 20%	33.5 + 12% - 20%
	weight kg	4.5 ± 15%	4.2 ± 15%	4.5 ± 15%
Trim tab	Moment kg cm	1.5 ± 15%	1.5 (1)	1.5 ± 15%
	Weight kg	0.52 ± 15%	0.52 ± 15%	0.52 ± 15%
Rudder	Moment kg cm	20.0 ± 10%	20.0 ± 10%	20.0 ± 10%
	weight kg	5.0 ± 10%	5.0 ± 10%	5.0 ± 10%
Aileron	Moment kg cm	12.0 ± 12%	12.0 ± 12%	10.0 ± 12%
	Weight kg	6.0 ± 10%	6.0 ± 10%	6.5 ± 10%
Modification	AM 315-8	TM 315-16	AM 315-14	AM 315-12 315-14
		(2)	(2)	(2)

- All measurement in kg or kgcm (1 kg = 2.2 lbs; 1 kgcm = 7.23 ft. lbs)

- The data was valid for the mentioned serial numbers when leaving the factory. There might be deviations after major repairs.

- See also technical data of tailplane at page 4 a.

(1) Without trim tab but with spring system for trimming.

(2) Beginning from s/n 3839 (K) elevator with V-section in the middle

26th Sept. 1984 (AM 315-14/2)

6. The controls including the brakes should be submitted to a functional test and the control deflections checked.
 7. If the controls do not move free throughout their range, search for the cause and correct.
 8. The 3 wheels and brake should be checked to be in good condition.
 9. The two hooks should be treated in accordance with their appropriate maintenance manual.
 10. Check the pitot for the ASI is clear and that the tubing to all instruments is in good condition and free of leaks or kinks.
 11. The condition and calibration of all instruments should be checked and any other equipment inspected.
 12. Equipment and instruments should be checked against the equipment list.
 13. The wing bending mode has to be established and checked with the figure stated at the approval report (Stückprüfbericht). The glider has to be supported at main-wheel and tail. The tire pressure must be 2,5-2,8 bar.
 14. After repair or change of equipment, the weight table should be updated with the new empty weight and center of Gravity by weighing or calculation.
- After extended storage check accordingly to regular service pos. 1 to 11 and inspect for evidence of rodents and birdness.

September 1981

VIII. Lubrication

Ball Bearings

All bearings installed are sealed with a permanent grease filling. Greasing of bearings is therefore unnecessary.

Sliding Bearings

All slide bearings installed on the fixed control linkages do not require servicing or greasing. However, the push rod bearings in the root rib and on the tailplane mounting should be cleaned with petrol and regreased when dirty. The pins and bushes on the wing fittings should be regreased when necessary during rigging.

The pins on the tailplane fittings and the screw thread should be lubricated periodically. The hinge and catch of the cover should be occasionally oiled. Dirty release hooks are best cleaned using a brush and compressed air whilst operating the mechanism. The belly hook is accessible from inside and can be lubricated with Sprayoil or similar.

September 1981

IX. General care

Dampness

As far as possible the glider should be protected from dampness. All the metal parts of the glider, with the exception of the wing and tailplane fittings are protected against damp. However, this will not prevent corrosion during extended exposure to moisture. Following any flights in rain any water which has entered the glider should be dried up and the exterior surfaces dried with a chamois leather. Polished metal parts should be regreased. Beware of condensation.

Sunlight

All structural parts of GFK glider should have white surfaces to avoid them heating up in sunlight.

Protection of the Finish

The Gelcoat surface layer is very resistant and can therefore be cleaned using a mild detergent. Ingrained dirt such as grease and dead flies, are best removed with a SILICONE-FREE polish (1 Z Spezial-Reiniger or "Reinigungspolish", Fa. Lesonal, Stuttgart). Sticky tape used for sealing the wing and tailplane joints may be removed using thinners of Petrol (Beware thinners may remove the markings).

Cleaning the Canopy

The canopy should only be cleaned using a soft clean cloth or sponge and a mild soap solution. It should be rinsed with clean water and dried with a chamois leather. "Plexipol" is a suitable polish. Never rub perspex with anything dry.



X. Airworthiness Limitations

This Airworthiness Limitations section is FAA approved for U.S. registered gliders in accordance with the provisions of 14 CFR section 21.29. In addition, this section is required by FAA Type Certificate Data Sheet No. G 39 EU and it specifies maintenance required under 14 CFR sections 43.16 and 91.163 unless an alternate program has been FAA approved.

LBA approved on : 17th march 1982

The following section specifies requirements for the instructions for continued airworthiness.

17 th march 1982



 17. März 1982

XI. 1 Annual Inspection Checklist

WING

- Finish
- Shell
- Cracks in shell
- Root rib

Spar stub

- Drain holes
- Fittings at root rib
- Aileron bearings
- Aileron drive
- Divebrake drive

TAILPLANE

- Finish
- Shell
- Cracks in shell
- Drain holes
- Bushes for mounting
- Elevator bearings

17 th march 1982

P. Pei
17. März 1982



FUSELAGE

- Finish
- Shell
- Cracks in shell
- Drain holes
- Rudder bearings
- Bushes for wing root pins
- Stabilizer mounting
- Cockpits
- Seats
- Frames
- Canopies
- Canopy mechanism
- Canopy emergency release
- Canopy window

- Control stick
- Elevator drive
- Divebrake drive
- Aileron drive
- Aileron connectors
- Divebrake connectors
- Trim control

- Pedals
- Pedal adjustment
- Steering cables
- Earth connections
- Cockpit ventilation
- Backrest adjustment
- Headrest adjustment

17 th march 1982

P. Pei
17. März 1982



Seat belt harness
 C. G. release
 Nose release
 Weight and balance plan
 Data placard
 Cockpit placards
 Placard with serial number
 Cockpit pocket
 Baggage compartment cover

ADJUSTMENT

Wings and horizontal tail
 Play at root ribs
 Zero setting of control surfaces
 Control surfaces deflections
 Dive brake deflection
 Wheel brake
 Trim control
 Nose release function
 C. G. release function
 Automatic C. G. release
 Aileron differentiation

Procedures and criteria for performing this inspection are contained in Section VII.3, page 22 of this manual.

P. Reich
 17. März 1982



17 th march 1982

Control surfaces (Aileron, Elevator, Rudder)
 Finish
 Shell
 Rudder ventilation
 Rudder drive
 Bearings
 Connecting means

LANDING GEAR (Mainwheel, Tailwheel, Nosewheel)

Undercarriage and axle
 Tyre
 Preset load at folding strut
 Bearings and joints
 Drive rod
 Connecting means
 Locking
 Overcenter
 Wheel brake system

EQUIPMENT

Minimum Instrumentation
 Additional Instrumentation
 Operating range
 Limit marks
 Oxygen bottles
 Working of Instrumentation
 Tubing
 Total energy unit
 Pitot system leakfree
 Static system leakfree
 T. E. system leakfree
 Electrical cables
 Battery and fitting
 Radio
 Antenna
 Compass deviation list

P. Reich
 17. März 1982



17 th march 1982

Control surfaces (Aileron, Elevator, Rudder)
 Finish
 Shell
 Rudder ventilation
 Rudder drive
 Bearings
 Connecting means

LANDING GEAR (Mainwheel, Tailwheel, Nosewheel)
 Undercarriage and axle

Tyre
 Preset load at folding strut
 Bearings and joints
 Drive rod
 Connecting means
 Locking
 Overcenter
 Wheel brake system

EQUIPMENT

Minimum instrumentation
 Additional instrumentation
 Operating range
 Limit marks
 Oxygen bottles
 Working of instrumentation
 Tubing

Total energy unit
 Pitot system leakfree
 Static system leakfree
 T. E. system leakfree
 Electrical cables
 Battery and fitting
 Radio
 Antenna

Compass deviation list

17 th march 1982

 17. März 1982

Seat belt harness
 C. G. release
 Nose release
 Weight and balance plan
 Data placard
 Cockpit placards
 Placard with serial number
 Cockpit pocket
 Baggage compartment cover

ADJUSTMENT

Wings and horizontal tail
 Play at root ribs
 Zero setting of control surfaces
 Control surfaces deflections
 Dive brake deflection
 Wheel brake
 Trim control
 Nose release function
 C. G. release function
 Automatic C. G. release
 Aileron differentiation

Procedures and criteria for performing this inspection are contained in Section VII.3, page 22 of this manual.

17 th march 1982

 17. März 1982

XI. 2. Inspection Procedure For Increase Of Service Time

1. General

The results of fatigue tests of wingspar sections have demonstrated recently that the service time of FRP gliders may be extended to 6000 hours, if for each individual glider (in addition to the obligatory annual inspections) the airworthiness is demonstrated according to a special multi-step inspection program particularly with regard to the service life.

2. Dates

When the glider has reached a service time of 3000 hours, an inspection must be done in accordance with the inspection program mentioned under point 3. If the results of this inspection are positive or if any defects found have been duly repaired, the service time of the glider is extended by another 1000 hours to a total of 4000 hours (first step).

The above inspection program must be repeated when the glider has reached a service time of 4000 hours. If the results of this inspection are positive or if any defects found have been duly repaired, the service time of the glider is extended to 5000 hours (second step).

When the glider has reached a service time of 5000 hours, the above inspection program again must be repeated. If the results of the inspection are still positive or if any defects found have been duly repaired, the service time may be extended to a total of 6000 hours (third step).

17 th march 1982



17. März 1982

For a possible service time exceeding 6000 hours, procedures will be evaluated in the future.

3. In each case the latest issue of the inspection program, which will be updated according to incoming inspection results, has to be ordered from the manufacturer.
4. The inspection must only be done by the manufacturer or by a licensed repair station or inspector.
5. The results of the inspections have to be recorded in an inspection test report wherein comments are required for each inspection in structure. If the inspections are done outside the manufacturer's facilities, a copy of the records must be sent to the manufacturer for his evaluation and information.
6. The annual inspection is not affected by this inspection program.

17 th march 1982



17. März 1982

XI.3. Components with a limited life time
a) Tow hooks

The E 75 and the G 73 Tost hooks are limited to 36 months after installation or 2000 launches which ever occurs first, at which time they are to be recertified by the manufacturer.

One is bound by the Maintenance Manuals for the nose hooks 'E 72' and 'E 75' published in May 1975 and the Maintenance Manual for the belly hooks 'Europa G 72' and 'Europa G 73' published in May 1975.

b) Oxygen Equipment

Overhaul times for specific Oxygen equipment is given in their test certificates.

Oxygen bottles must also be checked by the technical service every 5 years or according to the local laws on use of pressurized gases.

17 th march 1982



17. März 1982